

## MAX2090

# 50MHz to 1000MHz Analog VGA with Threshold Alarm Circuit and Error Amplifier for Level Control

### General Description

The MAX2090 high-linearity analog variable-gain amplifier (VGA) is a monolithic SiGe BiCMOS attenuator, amplifier, error amplifier, and alarm circuit, designed to interface with 50Ω systems operating in the 50MHz to 1000MHz frequency range. An external analog control voltage controls the analog attenuator. The device features a gain range of -10.9dB to +26.1dB, a noise figure of 4dB, OIP3 linearity of +38dBm, and a wide RF bandwidth. Each of these features makes the device an ideal VGA for numerous receiver and transmitter applications. In addition, the device operates from a single +5.0V supply.

This device is available in a compact 20-pin TQFN package (5mm x 5mm) with an exposed pad. Electrical performance is guaranteed over the extended temperature range, from  $T_C = -40^{\circ}\text{C}$  to  $+95^{\circ}\text{C}$ .

### Applications

Point-to-Point Receivers and Transmitters  
RF/IF Variable-Gain Stages  
Temperature-Compensation Circuits  
Cellular Applications  
WiMAX™ Applications  
LTE Applications  
Fixed Broadband Wireless Access  
Wireless Local Loop  
Military Systems

### Benefits and Features

- ◆ **Wideband Coverage**
  - ◇ 50MHz to 1000MHz RF Frequency Range
- ◆ **High Linearity**
  - ◇ +38dBm OIP3 (100MHz)
  - ◇ +17.5dBm Output -1dB Compression Point (100MHz)
- ◆ **26.1dB Gain**
- ◆ **37dB Attenuator Range**
- ◆ **4dB Noise Figure (Includes Attenuator Insertion Loss)**
- ◆ **0.25dB Gain Variation Over 100MHz Bandwidth**
- ◆ **Analog Attenuator Controlled with External Voltage**
- ◆ **Alarm Circuit with Adjustable Threshold**
- ◆ **Extended +4.75V to +5.8V Supply Range**
- ◆ **Lead(Pb)-Free Package**
- ◆ **Power-Down Capabilities**

[Ordering Information](#) appears at end of data sheet.

WiMAX is a trademark of WiMAX Forum.

For related parts and recommended products to use with this part, refer to: [www.maximintegrated.com/MAX2090.related](http://www.maximintegrated.com/MAX2090.related)

**For pricing, delivery, and ordering information, please contact Maxim Direct at 1-888-629-4642, or visit Maxim's website at [www.maximintegrated.com](http://www.maximintegrated.com).**

# MAX2090

## 50MHz to 1000MHz Analog VGA with Threshold Alarm Circuit and Error Amplifier for Level Control

### ABSOLUTE MAXIMUM RATINGS

V <sub>CC_A</sub> , V <sub>CC_RF</sub> .....	-0.3V to +6V	RF_OUT Output Power .....	+20dBm
RF_IN, RF_OUT .....	-0.3V to (V <sub>CC</sub> + 0.3V)	Continuous Power Dissipation (Note 1) .....	2.5W
R_BIAS, ALM_THRES, PLVLSET, AMP OUT.....	-0.3V to +3.6V	Operating Case Temperature Range (Note 2) ..	-40°C to +95°C
CTRL1, CTRL2 .....	-0.3V to +3.6V	Maximum Junction Temperature.....	+150°C
ALM .....	-0.3V to +3.6V	Storage Temperature Range.....	-65°C to +150°C
DET_VIN .....	-0.3V to +3.6V	Lead Temperature (soldering, 10s) .....	+300°C
RF_IN Input Power .....	+15dBm	Soldering Temperature (reflow) .....	+260°C

**Note 1:** Based on junction temperature  $T_J = T_C + (\theta_{JC} \times V_{CC} \times I_{CC})$ . This formula can be used when the temperature of the exposed pad is known while the device is soldered down to a PCB. See the [Applications Information](#) section for details. The junction temperature must not exceed +150°C.

**Note 2:**  $T_C$  is the temperature on the exposed pad of the package.  $T_A$  is the ambient temperature of the device and PCB.

Stresses beyond those listed under "Absolute Maximum Ratings" may cause permanent damage to the device. These are stress ratings only, and functional operation of the device at these or any other conditions beyond those indicated in the operational sections of the specifications is not implied. Exposure to absolute maximum rating conditions for extended periods may affect device reliability.

### PACKAGE THERMAL CHARACTERISTICS

TQFN

Junction-to-Ambient Thermal Resistance  $\theta_{JA}$  (Notes 3, 4) .. +29°C/W

Junction-to-Case Thermal Resistance  $\theta_{JC}$  (Notes 1, 4) .. 7°C/W

**Note 3:** Junction temperature  $T_J = T_A + (\theta_{JA} \times V_{CC} \times I_{CC})$ . This formula can be used when the ambient temperature of the PCB is known. The junction temperature must not exceed +150°C.

**Note 4:** Package thermal resistances were obtained using the method described in JEDEC specification JESD51-7, using a four-layer board. For detailed information on package thermal considerations, refer to [www.maximintegrated.com/thermal-tutorial](http://www.maximintegrated.com/thermal-tutorial).

### DC ELECTRICAL CHARACTERISTICS

([Typical Application Circuit](#), V<sub>CC</sub> = 4.75V to 5.8V, V<sub>GND</sub> = 0V, and T<sub>C</sub> = -40°C to +95°C. Typical values are at V<sub>CC</sub> = 5.5V, V<sub>PLVLSET</sub> = 2.5V, and T<sub>C</sub> = +25°C, unless otherwise noted.) (Note 5)

PARAMETER	SYMBOL	CONDITIONS	MIN	TYP	MAX	UNITS
Supply Voltage	V <sub>CC</sub>		4.75	5.0	5.8	V
Total Supply Current	I <sub>DC</sub>	CTRL1 = 1, CTRL2 = 1		81	110	mA
		CTRL1 = 1, CTRL2 = 0		71	100	
		CTRL1 = 0, CTRL2 = 0		5.7	15	
CTRL1/CTRL2 Logic-Low Input Voltage	V <sub>IL</sub>				0.8	V
CTRL1/CTRL2 Logic-High Input Voltage	V <sub>IH</sub>		2.2			V
CTRL1/CTRL2 Input Logic Current	I <sub>IH</sub> , I <sub>IL</sub>		-10		+10	μA
PLVLSET Input Resistance	R <sub>IN</sub>		650			kΩ
PLVLSET Input Voltage Range			0		2.5	V
PLVLSET Minimum Control Voltage			0	0.1	0.2	V

# MAX2090

## 50MHz to 1000MHz Analog VGA with Threshold Alarm Circuit and Error Amplifier for Level Control

### DC ELECTRICAL CHARACTERISTICS (continued)

([Typical Application Circuit](#),  $V_{CC} = 4.75V$  to  $5.8V$ ,  $V_{GND} = 0V$ , and  $T_C = -40^{\circ}C$  to  $+95^{\circ}C$ . Typical values are at  $V_{CC} = 5.5V$ ,  $V_{PLVLSSET} = 2.5V$ , and  $T_C = +25^{\circ}C$ , unless otherwise noted.) (Note 5)

PARAMETER	SYMBOL	CONDITIONS	MIN	TYP	MAX	UNITS
PLVLSSET Maximum Control Voltage			2.3	2.4	2.5	V
ALM_THRES Input Resistance			90	135		k $\Omega$
ALM_THRES Input Voltage Range		(Note 6)	0		2.5	V
ALM Output Logic 1			3.135	3.3	3.465	V
ALM Output Logic 0					0.4	V
DET_VIN Input Resistance			175	235	295	k $\Omega$

### RECOMMENDED AC OPERATING CONDITIONS

PARAMETER	SYMBOL	CONDITIONS	MIN	TYP	MAX	UNITS
RF Frequency	$f_{RF}$	(Note 7)	50		1000	MHz

### AC ELECTRICAL CHARACTERISTICS

([Typical Application Circuit](#) with analog attenuator set to minimum attenuation,  $V_{CC} = 4.75V$  to  $5.8V$ ,  $f_{RF} = 350MHz$ ,  $T_C = -40^{\circ}C$  to  $+95^{\circ}C$ , and RF ports are connected to  $50\Omega$  sources, unless otherwise noted. Typical values are at  $T_C = +25^{\circ}C$ ,  $V_{CC} = 5.5V$ ,  $PRF_{IN} = -25dBm$ ,  $V_{PLVLSSET} = 2.5V$ ,  $CTRL1 = 1$ ,  $CTRL2 = 0$ . Min/max specifications apply over supply, process, and temperature, unless otherwise noted.) (Note 8)

PARAMETER	SYMBOL	CONDITIONS	MIN	TYP	MAX	UNITS
Small-Signal Gain	G	$T_C = +25^{\circ}C$ , $V_{CC} = 5.0V$ (Note 6)	24.5	26.1		dB
		(Note 5)	23.5	26.1		
Gain vs. Temperature				-0.004		dB/ $^{\circ}C$
Maximum Gain Variation vs. Frequency		$f_{RF} \pm 50MHz$		0.25		dB
		$f_{RF} \pm 80MHz$		0.4		
		$f_{RF} \pm 100MHz$		0.5		
Noise Figure	NF	(Note 6)		4	5.7	dB
Total Attenuation Range		$V_{PLVLSSET} = 0.2V$ to $2.5V$ (Note 5)	35	37		dB
Group-Delay Variation		Within $\pm 50MHz$		150		ps
		Within $\pm 80MHz$		250		
		Within $\pm 100MHz$		300		
Output Third-Order Intercept Point (Note 6)	OIP3	$V_{PLVLSSET} = 2.5V$ , $PRF_{OUT} = 0dBm/$ tone, $f_{RF2} - f_{RF1} = 1MHz$	31.8	37.6		dBm
		$V_{PLVLSSET} = 0.7V$ , $PRF_{OUT} = 0dBm/$ tone, $f_{RF2} - f_{RF1} = 1MHz$	31.8	37.6		

# MAX2090

## 50MHz to 1000MHz Analog VGA with Threshold Alarm Circuit and Error Amplifier for Level Control

### AC ELECTRICAL CHARACTERISTICS (continued)

([Typical Application Circuit](#) with analog attenuator set to minimum attenuation,  $V_{CC} = 4.75V$  to  $5.8V$ ,  $f_{RF} = 350MHz$ ,  $T_C = -40^\circ C$  to  $+95^\circ C$ , and RF ports are connected to  $50\Omega$  sources, unless otherwise noted. Typical values are at  $T_C = +25^\circ C$ ,  $V_{CC} = 5.5V$ ,  $P_{RF\_IN} = -25dBm$ ,  $V_{PLVLSET} = 2.5V$ ,  $CTRL1 = 1$ ,  $CTRL2 = 0$ . Min/max specifications apply over supply, process, and temperature, unless otherwise noted.) (Note 8)

PARAMETER	SYMBOL	CONDITIONS	MIN	TYP	MAX	UNITS
Output Second-Order Intercept Point	OIP2	PRF_OUT = 0dBm/tone, $f_{RF2} - f_{RF1} = 1MHz$ , $f_{RF\_OUT} = f_{RF2} + f_{RF1}$		59.3		dBm
Output Second Harmonic		PRF_OUT = 0dBm		65.4		dBc
Output Third Harmonic		PRF_OUT = 0dBm		80.5		dBc
Output -1dB Compression Point	P1dB	(Note 9)	14	17.6		dBm
Average Gain-Control Slope		VPLVLSET = 0.5V to 2.0V (Note 6)	16.5	19.5	23.0	dB/V
Maximum Gain-Control Slope		VPLVLSET = 0 to 2.5V		25		dB/V
VGA Reverse Isolation				35		dB
Attenuator Response Time		PRF_IN = -15dBm, VPLVLSET = 2.5V to 1.2V, output settled within $\pm 0.5dB$ of final value		330		ns
		PRF_IN = -15dBm, VPLVLSET = 1.2V to 2.5V, output settled within $\pm 0.5dB$ final value		220		
Insertion Phase Change		VPLVLSET = 2.5V to 0V		11		Degrees
RF_IN Return Loss		$Z_S = 50\Omega$ , over full attenuation range (Note 6)	13.5	20		dB
RF_OUT Return Loss		$Z_L = 50\Omega$ over full attenuation range (Note 6)	13.5	20		dB
<b>ERROR AMPLIFIER AND ALARM CIRCUIT (CTRL1 = CTRL2 = 1)</b>						
Maximum AMP_OUT Capacitance to GND		(Note 7)			20	pF
ALM Threshold		ALM_THRES open (Input = DET_VIN)		1.35		V

**Note 5:** Production tested and guaranteed at  $T_C = +95^\circ C$  for worst-case supply voltage. Performance at  $T_C = +25^\circ C$  and  $T_C = -40^\circ C$  are guaranteed by design and characterization for worst-case supply voltage.

**Note 6:** Guaranteed by design and characterization.

**Note 7:** Recommended functional range. Not production tested. Operation outside this range is possible, but with degraded performance of some parameters.

**Note 8:** All limits include external component losses. Output measurements were taken at the RF\_OUT port.

**Note 9:** It is advisable not to continuously operate the RF\_IN input power above 11dBm, and RF\_OUT power above 19dBm.

# MAX2090

## 50MHz to 1000MHz Analog VGA with Threshold Alarm Circuit and Error Amplifier for Level Control

### Typical Operating Characteristics

(Typical Application Circuit with analog attenuator set to minimum attenuation ( $V_{PLVSET} = 2.5V$ ),  $V_{CC} = 5.5V$ ,  $T_C = +25^\circ C$ ,  $f_{RF\_IN} = 350MHz$ ,  $P_{RF\_IN} = -25dBm$ ,  $R_{SOURCE} = R_{LOAD} = 50\Omega$ ,  $CTRL1 = 1$ ,  $CTRL2 = 0$ ,  $ALM\_THRES = ALM = open$ , unless otherwise noted.)

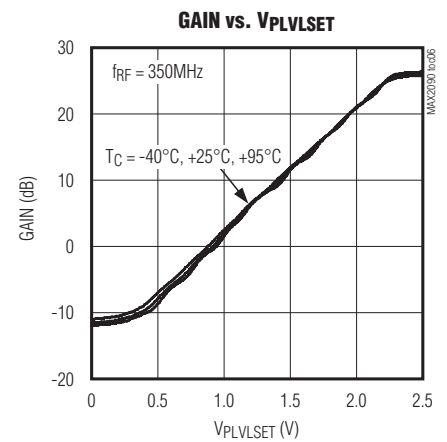
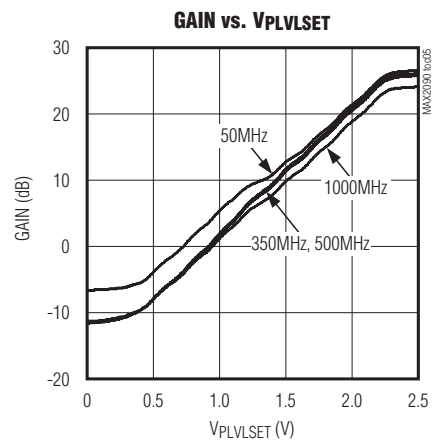
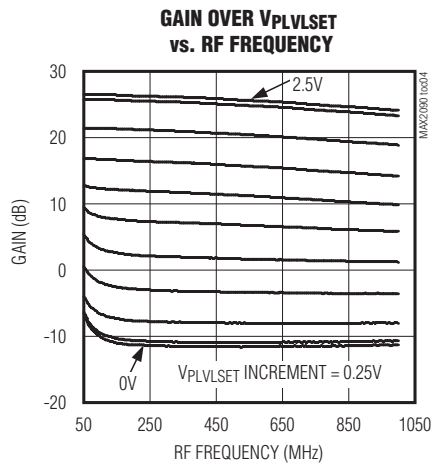
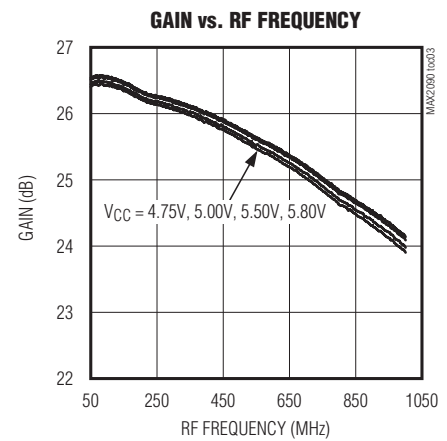
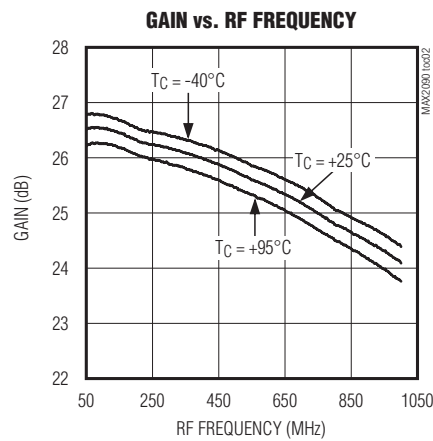
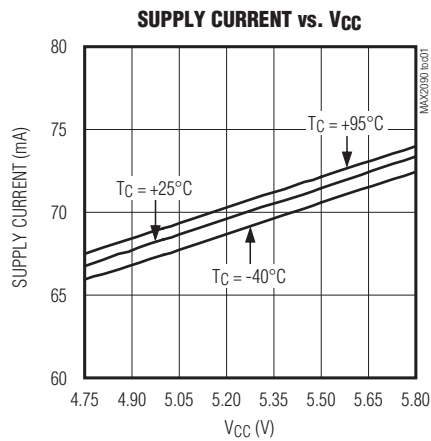

# MAX2090

## 50MHz to 1000MHz Analog VGA with Threshold Alarm Circuit and Error Amplifier for Level Control

### Typical Operating Characteristics (continued)

(Typical Application Circuit with analog attenuator set to minimum attenuation ( $V_{PVLVSET} = 2.5V$ ),  $V_{CC} = 5.5V$ ,  $T_C = +25^\circ C$ ,  $f_{RF\_IN} = 350MHz$ ,  $P_{RF\_IN} = -25dBm$ ,  $R_{SOURCE} = R_{LOAD} = 50\Omega$ ,  $CTRL1 = 1$ ,  $CTRL2 = 0$ ,  $ALM\_THRES = ALM = open$ , unless otherwise noted.)

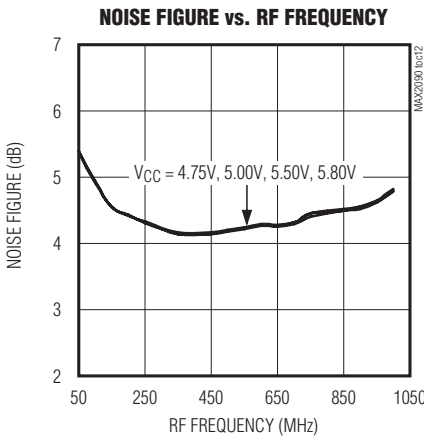
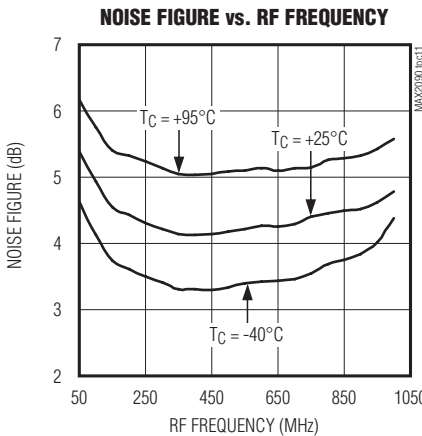
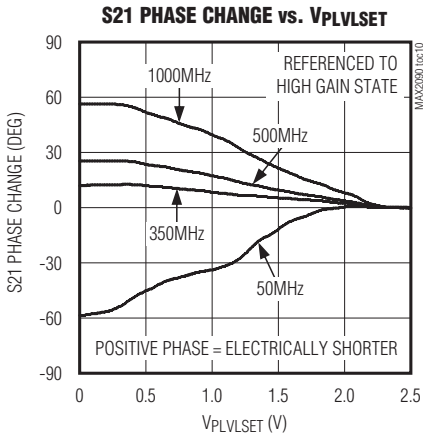
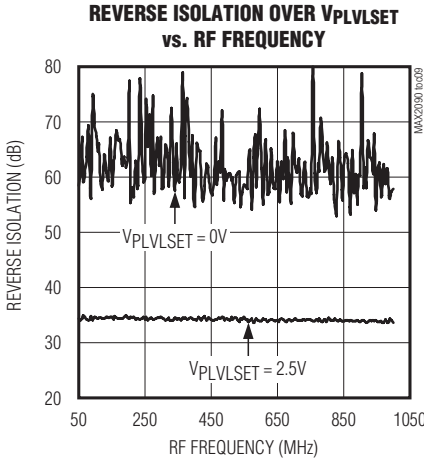
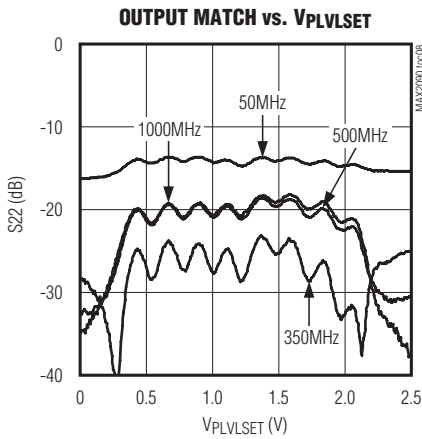
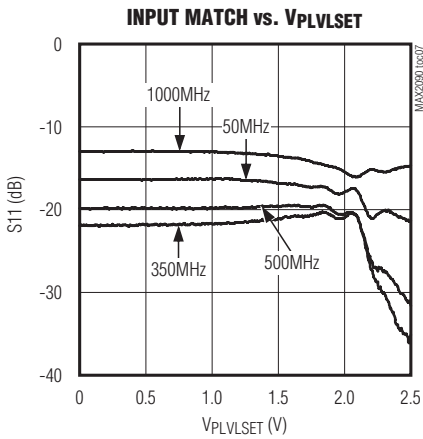

# MAX2090

## 50MHz to 1000MHz Analog VGA with Threshold Alarm Circuit and Error Amplifier for Level Control

### Typical Operating Characteristics (continued)

(Typical Application Circuit with analog attenuator set to minimum attenuation ( $V_{PLVSET} = 2.5V$ ),  $V_{CC} = 5.5V$ ,  $T_C = +25^\circ C$ ,  $f_{RF\_IN} = 350MHz$ ,  $P_{RF\_IN} = -25dBm$ ,  $R_{SOURCE} = R_{LOAD} = 50\Omega$ ,  $CTRL1 = 1$ ,  $CTRL2 = 0$ ,  $ALM\_THRES = ALM = open$ , unless otherwise noted.)

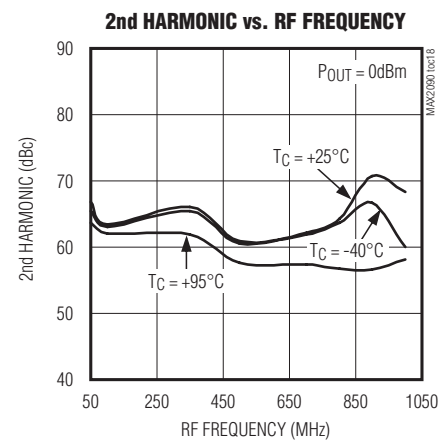
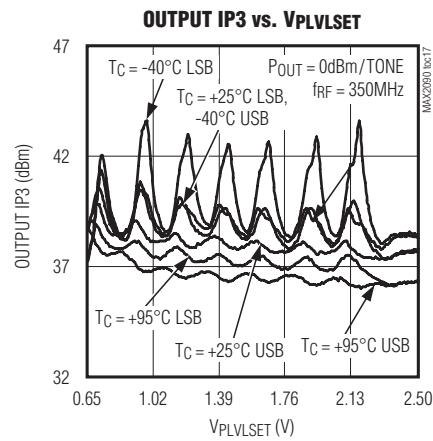
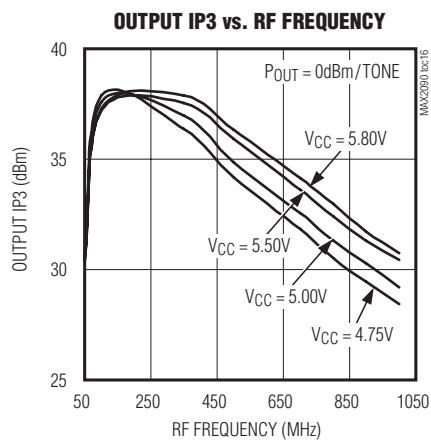
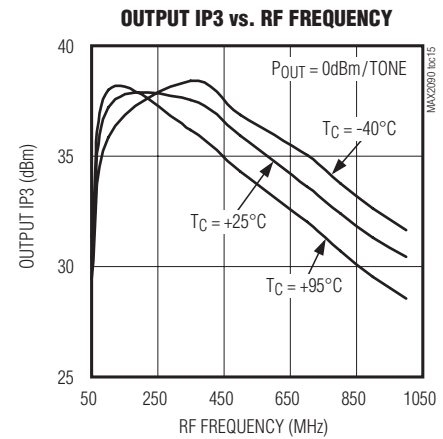
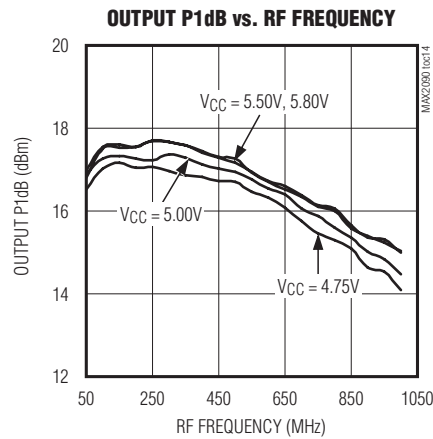
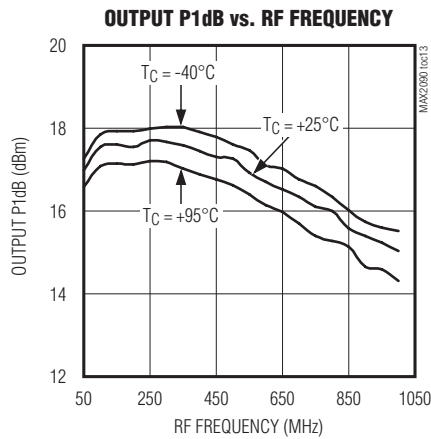

# MAX2090

## 50MHz to 1000MHz Analog VGA with Threshold Alarm Circuit and Error Amplifier for Level Control

### Typical Operating Characteristics (continued)

(Typical Application Circuit with analog attenuator set to minimum attenuation ( $V_{PLVLSSET} = 2.5V$ ),  $V_{CC} = 5.5V$ ,  $T_C = +25^\circ C$ ,  $f_{RF\_IN} = 350MHz$ ,  $P_{RF\_IN} = -25dBm$ ,  $R_{SOURCE} = R_{LOAD} = 50\Omega$ ,  $CTRL1 = 1$ ,  $CTRL2 = 0$ ,  $ALM\_THRES = ALM = open$ , unless otherwise noted.)

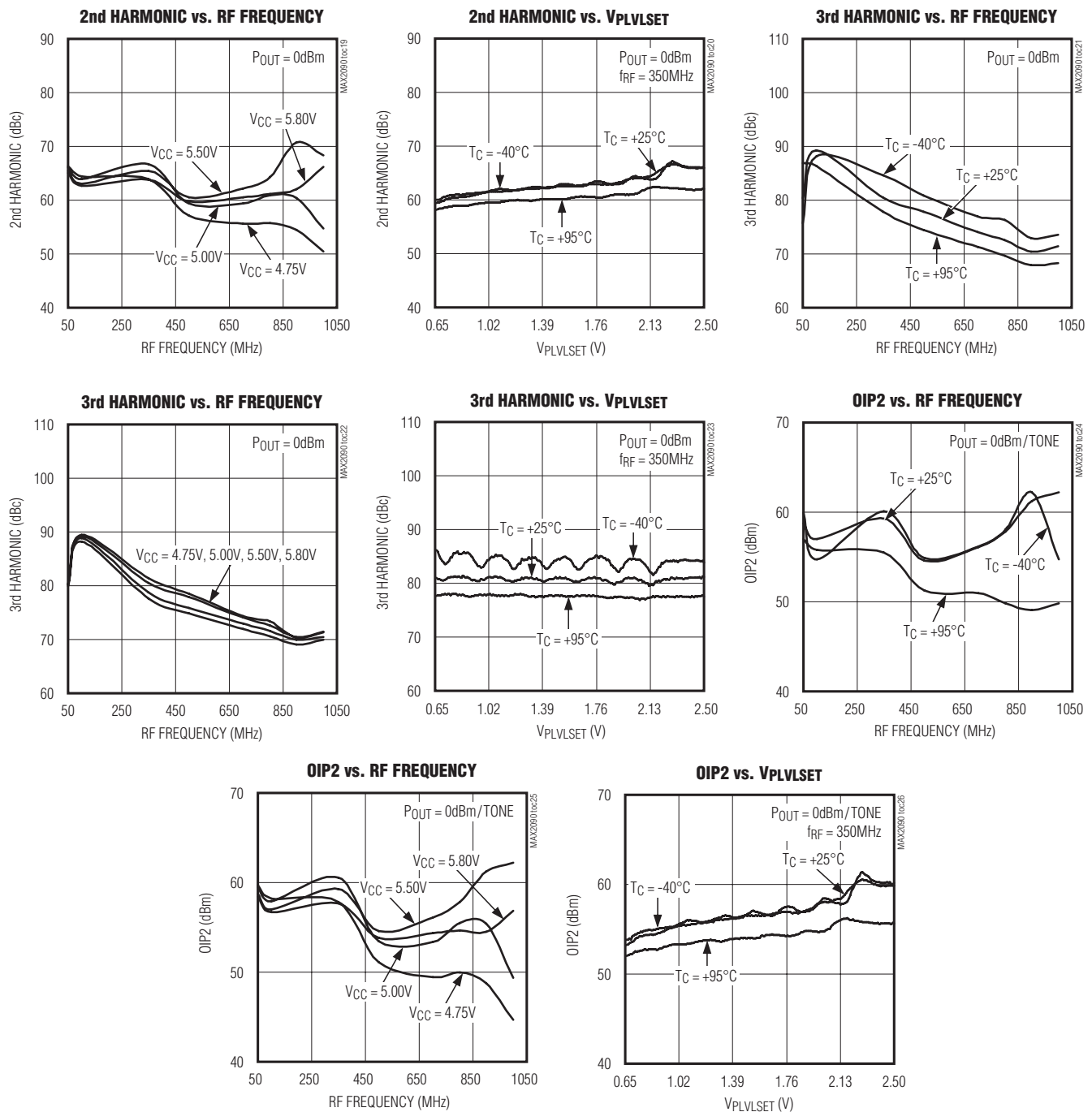



# MAX2090

## 50MHz to 1000MHz Analog VGA with Threshold Alarm Circuit and Error Amplifier for Level Control

**Functional Block Diagram**

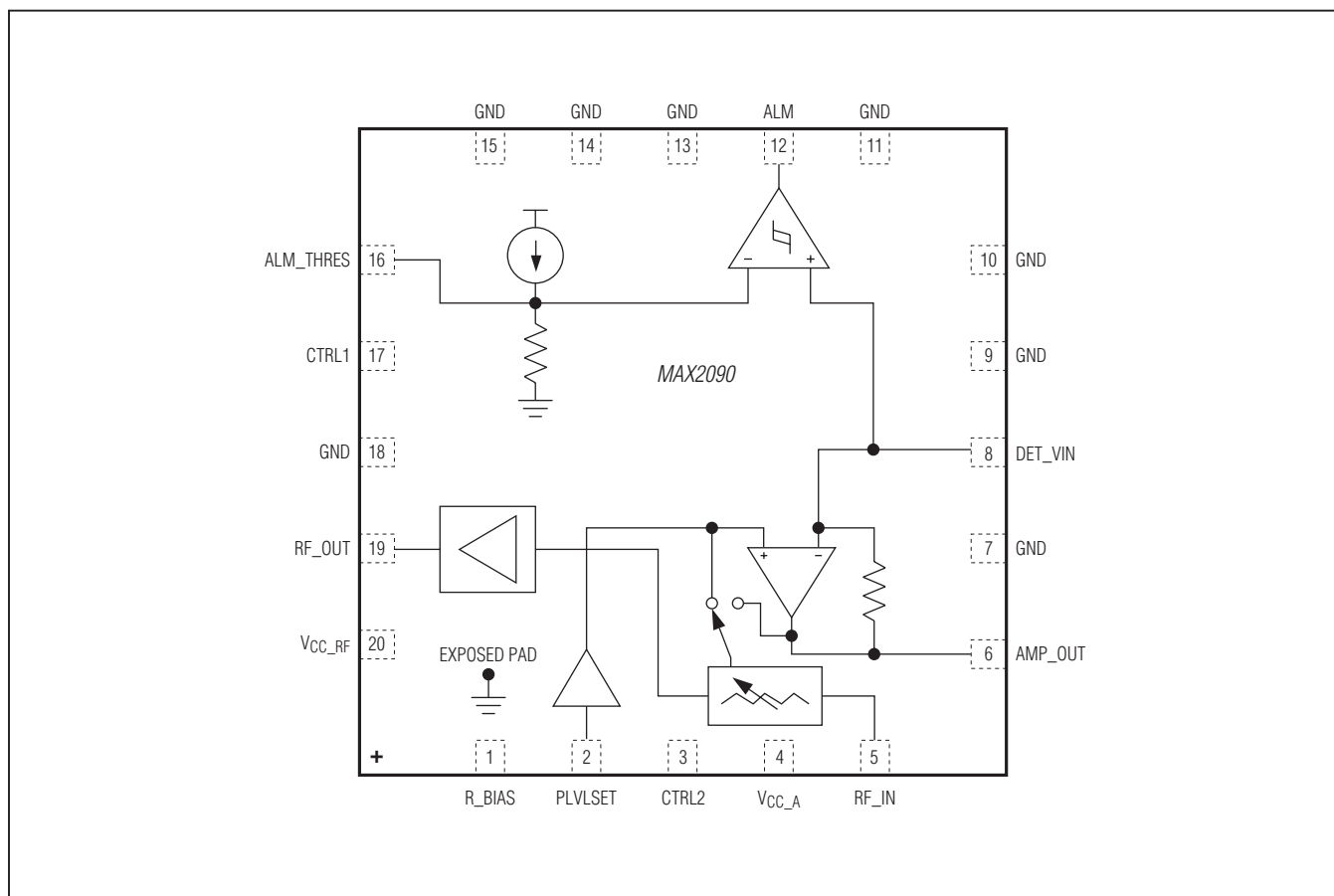

# MAX2090

## 50MHz to 1000MHz Analog VGA with Threshold Alarm Circuit and Error Amplifier for Level Control

### Pin Configuration

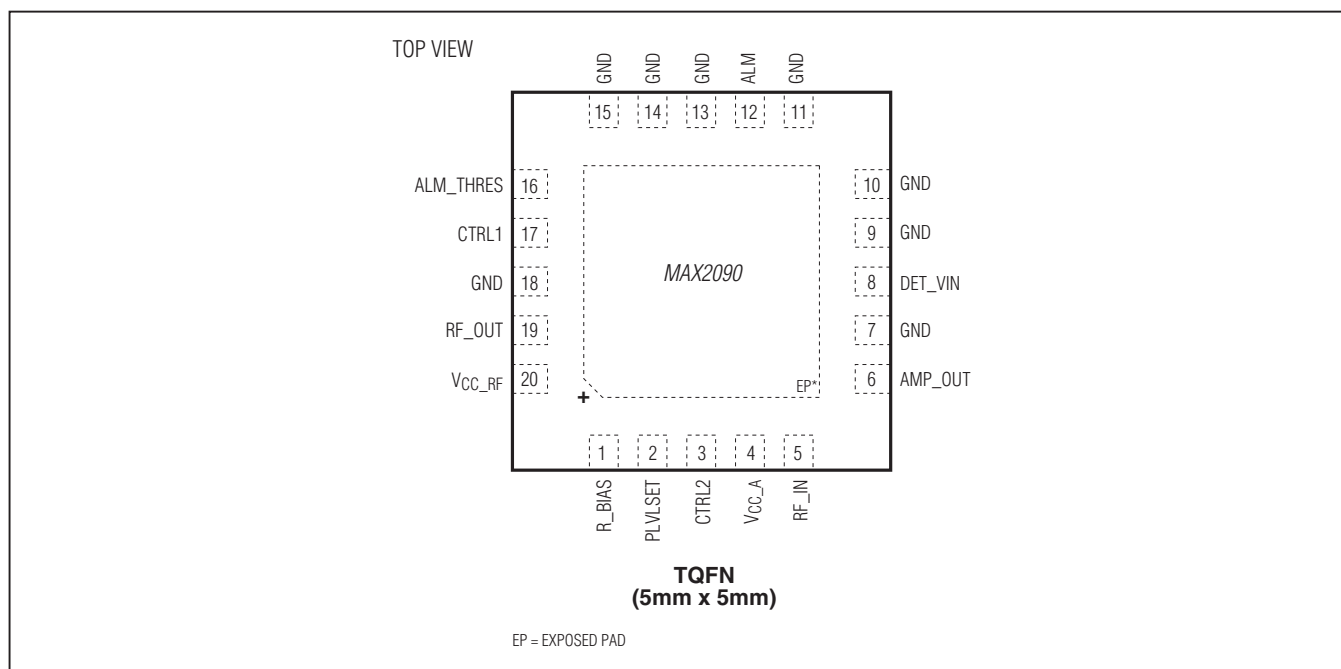

### Pin Description

PIN	NAME	FUNCTION
1	R_BIAS	Bias Resistor Setting Input. Connect a resistor from this pin to ground.
2	PLVLSET	AGC Loop Threshold-Level Input/Attenuator Control
3	CTRL2	Functional Control Bit (see Table 1)
4	V <sub>CC_A</sub>	Power-Supply Input. Bypass to ground with a 10nF capacitor as close as possible to the pin.
5	RF_IN	Attenuator Input (50Ω). Requires a DC-blocking capacitor.
6	AMP_OUT	Error Amplifier Output
8	DET_VIN	Error Amplifier Input Voltage from an External Detector
7, 9, 10, 11, 13, 14, 15, 18	GND	Ground
12	ALM	Alarm Logic Output
16	ALM_THRES	Alarm Threshold Voltage Input. See the <i>Alarm Operation</i> section for operation details.
17	CTRL1	Functional Control Bit (see Table 1)
19	RF_OUT	RF Output (50Ω). See the <i>Typical Application Circuit</i> for connection details.
20	V <sub>CC_RF</sub>	Driver Amplifier Supply Voltage Input. Bypass to ground with a 10nF capacitor as close as possible to the pin.
—	EP	Exposed Pad. Internally connected to ground. Connect to GND for proper RF performance and enhanced thermal dissipation.

# MAX2090

## 50MHz to 1000MHz Analog VGA with Threshold Alarm Circuit and Error Amplifier for Level Control

### Detailed Description

The MAX2090 is a high-linearity analog VGA designed to interface with 50Ω systems operating in the 50MHz to 1000MHz frequency range. An external analog control voltage controls the analog attenuator. The device features a gain range of -10.9dB to +26.1dB, a noise figure of 4dB, OIP3 linearity of +38dBm, and a wide RF bandwidth. Each of these features makes the device an ideal VGA for numerous receiver and transmitter applications. In addition, the device operates from a single +5.0V supply.

### Applications Information

#### Modes of Operation

The device can operate in several different modes, as summarized in [Table 1](#).

#### VGA-Only Mode Operation

VGA-only mode operation consists of setting CTRL1 = logic 1 and CTRL2 = logic 0, and applying a DC value to PLVLSET between 0 and 2.5V DC to manually adjust the attenuator and subsequently the RF\_OUT power to any desired value. The output power at RF\_OUT increases at a rate of 19.5dB/V as PLVLSET is increased. The error amplifier and alarm are powered off in this mode, reducing the supply current by 10mA typical. In VGA-only mode, components R5, R7, C8, C9, and C16 can be left unpopulated.

#### Closed-ALC Mode Operation

Closed-ALC mode operation consists of setting CTRL1 = CTRL2 = logic 1. In this mode, the DET\_IN input is driven from an external detector through R7. Ideally, a power detector with an output voltage range of 0.1V to 2.4V DC is recommended, but the MAX2090 operates with any detector whose output ranges from 0 to 2.5V DC. PLVLSET is used to set the RF\_OUT power by comparing it to the DET\_VIN (pin 8) voltage in the error amplifier. As PLVLSET increases, the power at RF\_OUT also increases. Components R5, C8, and C9 are installed to set the response time of the loop. See the *Typical Application Circuit*. This loop acts to maintain the input power to the external detector by driving the attenuator in servo fashion as the power level into RF\_IN changes. PLVLSET can be externally driven to a DC value between 0 and 2.5V, such that the desired power is present at RF\_OUT.

#### Control Inputs

The MAX2090 has four control inputs: CTRL1, CTRL2, ALM\_THRES, and PLVLSET. V<sub>CC</sub> must be present before voltages are applied to these pins. In cases where this is not possible, a 200Ω resistor must be included in series with the control inputs to limit on-chip ESD diode conduction. CTRL1 and CTRL2 are 3V logic controls and cannot be driven from 5V logic. In the case where no logic control is available and a logic-high is required, a voltage-divider can be used from the 5V V<sub>CC</sub> supply to produce the 3V logic-high.

**Table 1. Mode Control Logic**

CTRL1	CTRL2	VGA	ERROR AMPLIFIER	ALC LOOP	ALARM	FUNCTION DESCRIPTION
0	0	Disabled	Disabled	Disabled	Disabled	Power-down mode
1	1	Enabled	Enabled	Enabled	Enabled	Closed-ALC mode: ALC loop locks DET_VIN to PLVLSET
1	0	Enabled	Disabled	Disabled	Disabled	VGA-only mode
0	1	—	—	—	—	Factory test mode (do not use)

# MAX2090

## 50MHz to 1000MHz Analog VGA with Threshold Alarm Circuit and Error Amplifier for Level Control

### Alarm Operation

The alarm ALM output remains in a logic-high state while DET\_VIN is above the 1.35V nominal. ALM\_THRES has 135k $\Omega$  input resistance and is set internally to 1.35V (typ) such that ALM triggers when DET\_VIN is below 1.35V. Alternatively, the voltage on ALM\_THRES can be externally driven to allow alternative power-level trip points. When DET\_IN is used to drive the DET\_VIN pin through R7, the nominal value for ALM logic-high is typically above 1.22V at DET\_IN. The ALM comparator has typical hysteresis of 29mV.

### Layout Considerations

The pin configuration of the MAX2090 is optimized to facilitate a very compact physical layout of the device and its associated discrete components. The exposed pad (EP) of the device's 20-pin TQFN-EP package provides a low thermal-resistance path to the die. It is important that the PCB on which the device is mounted be designed to conduct heat from the EP. In addition, provide the EP with a low inductance path to electrical ground. The EP **MUST** be soldered to a ground plane on the PCB, either directly or through an array of plated via holes.

**Table 2. Typical Application Circuit Component Values**

COMPONENT	MODE OF OPERATION		VALUE	SIZE	SUPPLIER	DESCRIPTION
	VGA ONLY	CLOSED ALC				
C1, C5	√	√	1000pF	0402	Murata	C0G dielectric
C2, C3	√	√	0.01 $\mu$ F	0402	Murata	X7R dielectric
C8	—	√	100nF	0603	Murata	X7R dielectric
C9	—	√	820pF	0402	Murata	C0G dielectric
C14*	—		Do not install	0402	—	—
C16	—	√	0.01 $\mu$ F	0402	Murata	X7R dielectric
L1	√	√	330nH	0603	Coilcraft	Ferrite LS series 5% tolerance
R1	√	√	1.78k $\Omega$	0402	Panasonic	1% tolerance
R5	—	√	150 $\Omega$	0402	Panasonic	1% tolerance
R7	—	√	24k $\Omega$	0402	Panasonic	5% tolerance
R11*	√	√	0 $\Omega$	0402	Panasonic	1% tolerance
U1	√	√	—	20-pin TQFN (5mm x 5mm)	Maxim	MAX2090ETP+

**Note:** The checkmarks in the Mode of Operation columns indicate that the component is used within each respective application.

\*C14 and R11 form an optional lowpass network to filter out potential noise from the external PLVLSET control source.

# MAX2090

## 50MHz to 1000MHz Analog VGA with Threshold Alarm Circuit and Error Amplifier for Level Control

### Typical Application Circuit

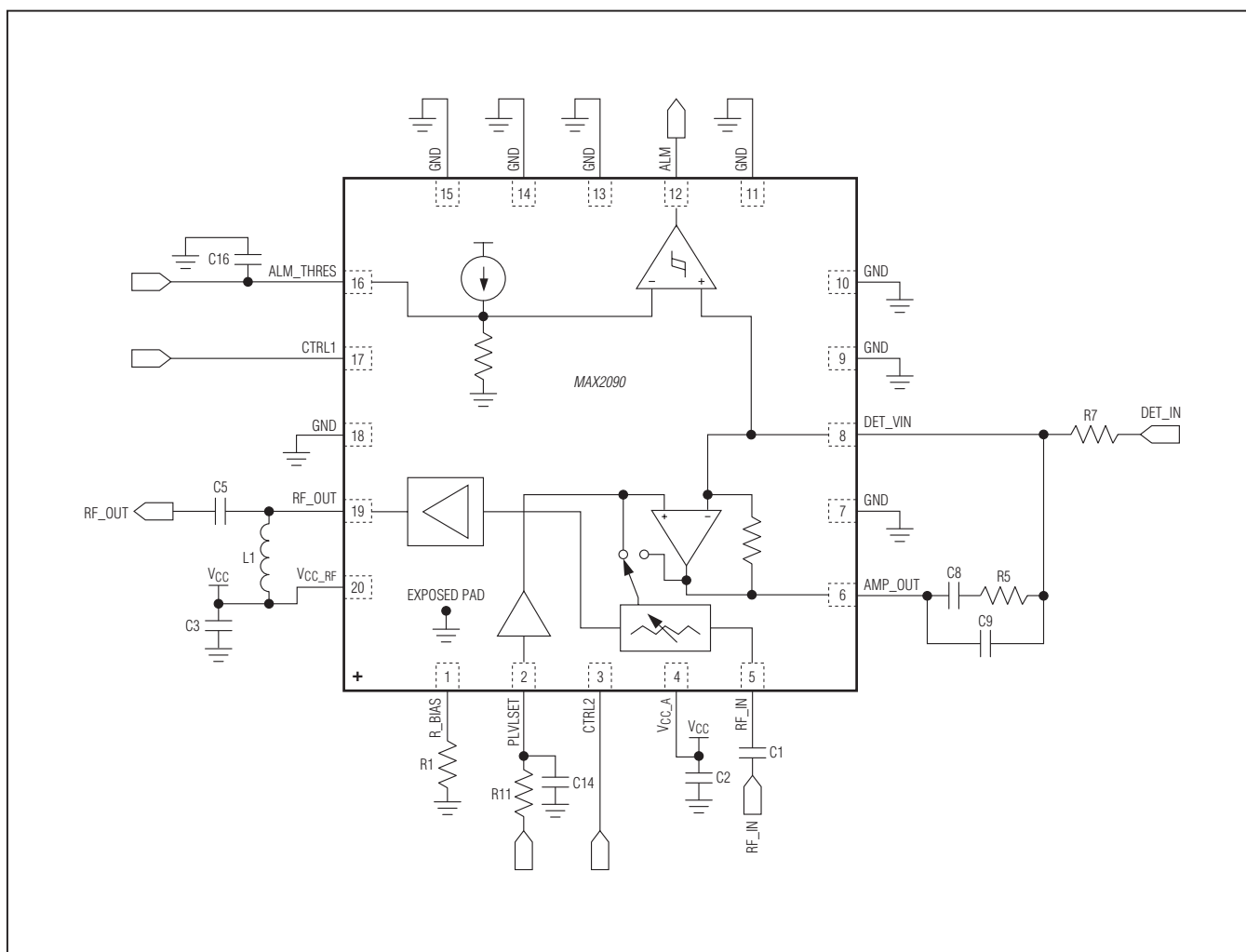

### Ordering Information

PART	TEMP RANGE	PIN-PACKAGE
MAX2090ETP+	-40°C to +95°C	20 TQFN-EP*
MAX2090ETP+T	-40°C to +95°C	20 TQFN-EP*

+ Denotes a lead(Pb)-free/RoHS-compliant package.

\*EP = Exposed pad.

T = Tape and reel.

### Chip Information

PROCESS: SiGe BiCMOS

### Package Information

For the latest package outline information and land patterns (footprints), go to [www.maximintegrated.com/packages](http://www.maximintegrated.com/packages). Note that a "+", "#", or "-" in the package code indicates RoHS status only. Package drawings may show a different suffix character, but the drawing pertains to the package regardless of RoHS status.

PACKAGE TYPE	PACKAGE CODE	OUTLINE NO.	LAND PATTERN NO.
20 TQFN-EP	T2055+5	<a href="#">21-0140</a>	<a href="#">90-0010</a>

# MAX2090

## 50MHz to 1000MHz Analog VGA with Threshold Alarm Circuit and Error Amplifier for Level Control

### Revision History

REVISION NUMBER	REVISION DATE	DESCRIPTION	PAGES CHANGED
0	9/11	Initial release	—
1	9/12	Updated existing data sheet to remove references to detector circuit, added 26 new TOCs, updated <i>Electrical Characteristics</i> table, updated Table 12	1–14



Maxim cannot assume responsibility for use of any circuitry other than circuitry entirely embodied in a Maxim product. No circuit patent licenses are implied. Maxim reserves the right to change the circuitry and specifications without notice at any time. The parametric values (min and max limits) shown in the *Electrical Characteristics* table are guaranteed. Other parametric values quoted in this data sheet are provided for guidance.

**Maxim Integrated 160 Rio Robles, San Jose, CA 95134 USA 1-408-601-1000**

14